

Braced Post Insulator Assembly B2901038T12058MX

1) H2 90 10 027 MX SS 014	[1]
2) S1 40 80 025 MX AL 015	[1]
3) Socket/Y-Clevis (SYC-56)	[1]
4) Turnbuckle (G-227-NBC-3/4x6C)	[1]
5) Shackle (ASH-55-BC)	[1]

ASSEMBLY DIMENSIONAL VALUES

Post Section Length (PSL)	37.6 in	955 mm
Suspension Section Length (SSL)	36.2 in	919 mm
Height of Assembly (H)	58.0 in	1,473 mm
Length of Brace (B)	60.4 in	1,534 mm
Upper Pole Connection Offset (A)*	2.0 in	51 mm
Angle Between Insulators (C)		66 Degrees
Dry Arc Distance	26.8 in	681 mm
Leakage Distance	66.9 in	1,699 mm

*This connection bracket to be supplied by customer

ASSEMBLY ELECTRICAL VALUES*

60 Hz Dry F.O. (Min. Withstand)	266 kV	(249) kV
60 Hz Wet F.O. (Min. Withstand)	243 kV	(187) kV
CIFO+ (Min. Withstand)	452 kV	(404) kV
CIFO- (Min. Withstand)	547 kV	(439) kV

*Values shown are based on minimum electricals for the assembly

ASSEMBLY MECHANICAL VALUES

Maximum Working Vertical Load	11,734 lbs	52.2 kN
-------------------------------	------------	---------

This drawing contains confidential information that is the property of MacLean Power, L.L.C. ("MacLean"). Use of MacLean's confidential information without MacLean's express written consent is strictly prohibited and may expose you to legal liability. If you believe that you received this material in error, please destroy it or return it to "MacLean Power, L.L.C., 7801 Park Place Rd., York, South Carolina 29745, USA."

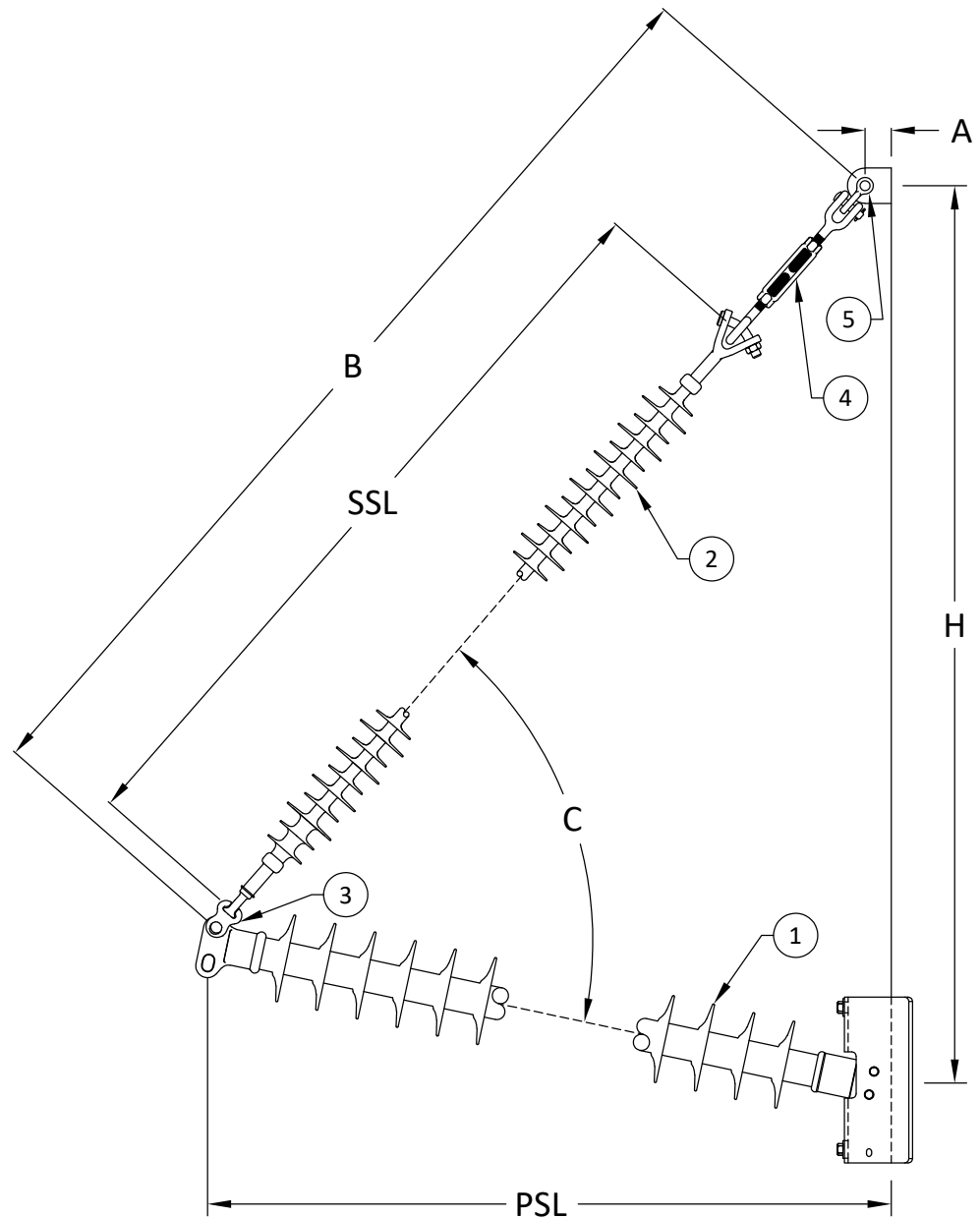

MPS Catalog Number

H2 90 10 027 MX SS 014

Date: 03/23/2022

End Fittings

Tower End Fitting:

Gain / 12 deg / Steel

Line End Fitting:

2 HL Drop Tongue / Galv. Ductile Iron

Material

Corona Ring (Line):

None

Corona Rings are recommended for applications of 230 kV and above

Mounting Angle:

12 deg

Number of Sheds:

14

Rod Diameter:

2.5 in

Weight Estimate:

48.9 lbs

22 kg

Dimensional Values

Section Length (L):

37.6 in 955 mm

Rubber Length (X):

27 in 686 mm

Shed spacing (S):

1.95 in 50 mm

Shed Projection (P):

1.86 in 47 mm

Dry Arc Distance:

29.5 in 749 mm

Leakage Distance:

74.4 in 1,889 mm

Electricals Values

60 Hz dry Flashover (Min. Withstand):

290 kV 272 kV

60 Hz Wet Flashover (Min. Withstand):

266 kV 206 kV

CIFO Positive (Min. Withstand):

495 kV 443 kV

CIFO Negative (Min. Withstand):

589 kV 478 kV

Mechanical Values

Max. Design Cant. Load (MDCL):

2,573 lbs 11.4 kN

Specified Cant. Load (SCL):

5,146 lbs 22.9 kN

Specified Tensile Load (STL):

15,000 lbs 66.7 kN

This drawing contains confidential information that is the property of MacLean Power, L.L.C. ("MacLean"). Use of MacLean's confidential information without MacLean's express written consent is strictly prohibited and may expose you to legal liability. If you believe that you received this material in error, please destroy it or return it to "MacLean Power, L.L.C., 7801 Park Place Rd., York, South Carolina 29745, USA."

Notes:

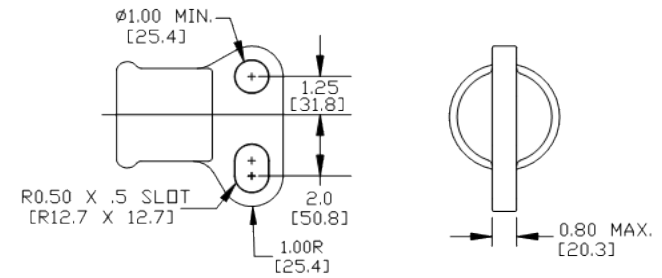
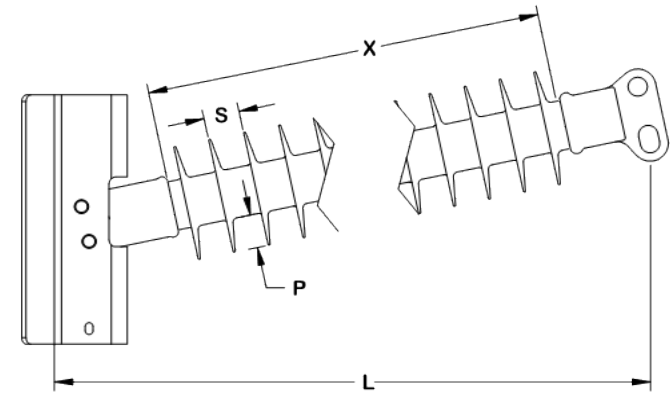
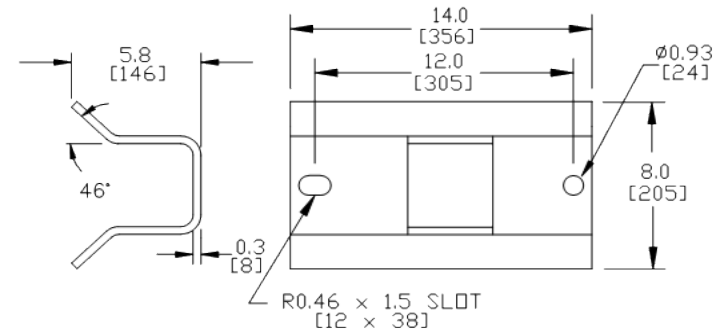

Dimension: inches [millimeters]

NOTE: Drawing not actual depiction of insulator appearance.

Silicone rubber sheath and sheds complies with applicable ANSI and IEC standards.

Prepared By: Stephen Lucci

MPS Catalog Number

S1 40 80 025 MX AL 015

Date: 03/22/2022

End Fittings

Tower End Fitting:

Y-Clevis / Forged Steel

Line End Fitting:

Ball / Forged Steel
/ (ANSI 52-5)

Material

Corona Ring (Line):

None

Corona Rings are recommended for applications of 230 kV and above

Number of Sheds:

7 large 8 standard

Rod Diameter:

16 mm

Weight Estimate:

7.3 lbs 3 kg

Dimensional Values

Section Length (L):

36.2 in 919 mm

Rubber Length (X):

25 in 635 mm

Standard Shed Height (P1):

1.5 in 38 mm

Large Shed Height (P2):

2 in 51 mm

Projection Ration (S/P):

- 1.5

Shed Spacing (S):

3 in 76 mm

Dry Arc Distance:

26.8 in 681 mm

Leakage Distance:

66.9 in 1,699 mm

Electricals Values

60 Hz dry Flashover (Min. Withstand):

269 kV 251 kV

60 Hz Wet Flashover (Min. Withstand):

243 kV 212 kV

CIFO Positive (Min. Withstand):

468 kV 403 kV

CIFO Negative (Min. Withstand):

503 kV 444 kV

Mechanical Values

Specified Mech. Load (SML):

25,000 lbs 111.2 kN

Routine Test Load (RTL):

12,500 lbs 55.6 kN

Notes:

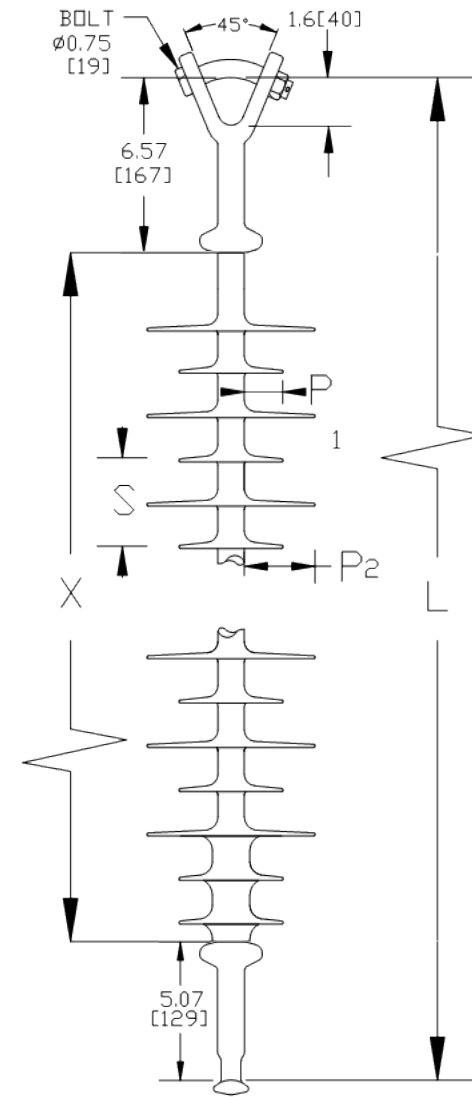

Dimension: inches [millimeters]

NOTE: Drawing not actual depiction of insulator appearance.

Silicone rubber sheath and sheds complies with applicable ANSI and IEC standards.

Prepared By: Stephen Lucci



MacLean Power Systems

B2901038T12058MX Ultimate Combined Load Curve

Factor of Safety = 1



Assumptions:
-Loading sequence is Longitudinal, Vertical, Transverse
-Factor of Safety applied to entire system
-Negligible downward tip deflection
-Static moduli values
-Confidence level of 95%

