

MPS Catalog Number:

H2 90 10 082 AA SS 032

Date:

05/20/2021

End Fittings

Tower End Fitting:

Gain / 12 deg / Steel

Line End Fitting:

Anchor / Ductile Iron
2 HL Drop Tongue / Galv. Ductile Iron

Material

Corona Ring (Tower):

None

Corona Ring (Line):

6" Corona Ring

Corona Rings are recommended for applications of 230 kV and above

Mounting Angle:

12 deg

Number of Sheds:

32

Rod Diameter:

2.5 in

Weight Estimate:

98 lbs

44 kg

Dimensional Values

Section Length (L):

91.4 in 2,322 mm

Rubber Length (X):

82 in 2,083 mm

Shed spacing (S):

2.5 in 64 mm

Shed Projection (P):

2.4 in 61 mm

Dry Arc Distance:

82.8 in 2,103 mm

Leakage Distance:

226 in 5,740 mm

Electricals Values

60 Hz dry Flashover (Min. Withstand):

756 kV 709 kV

60 Hz Wet Flashover (Min. Withstand):

685 kV 557 kV

CIFO Positive (Min. Withstand):

1328 kV 1169 kV

CIFO Negative (Min. Withstand):

1352 kV 1222 kV

Mechanical Values

Max. Design Cant. Load (MDCL):

967 lbs 4.3 kN

Specified Cant. Load (SCL):

1,934 lbs 8.6 kN

Specified Tensile Load (STL):

15,000 lbs 66.7 kN

This drawing contains confidential information that is the property of MacLean Power, L.L.C. ("MacLean"). Use of MacLean's confidential information without MacLean's express written consent is strictly prohibited and may expose you to legal liability. If you believe that you received this material in error, please destroy it or return it to "MacLean Power, L.L.C., 7801 Park Place Rd., York, South Carolina 29745, USA."

Notes:

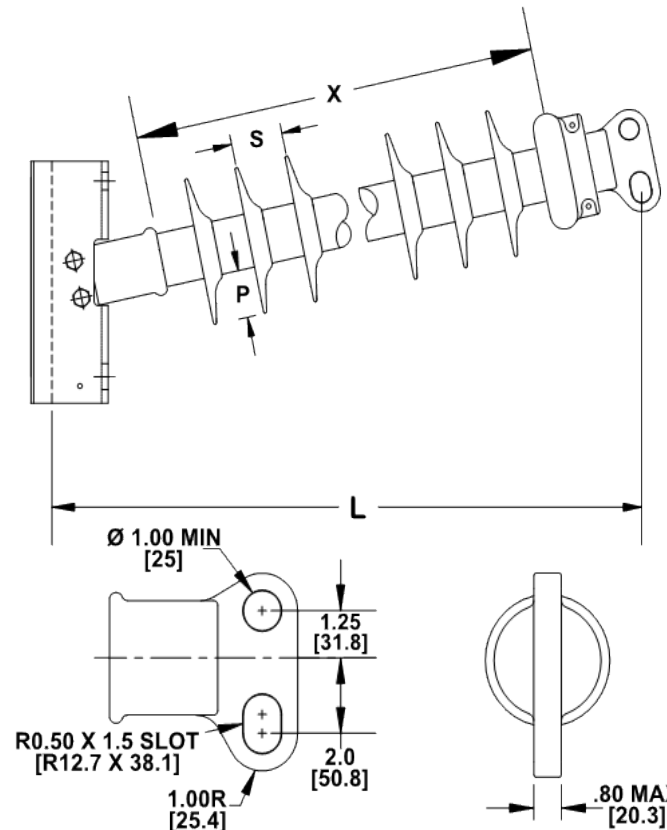
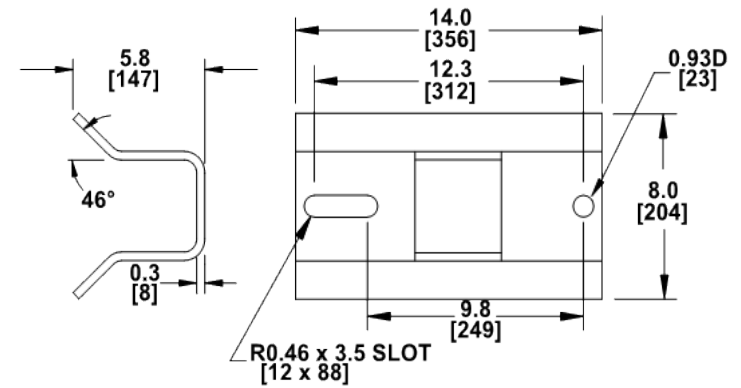

Dimension: inches [millimeters]

NOTE: Drawing not actual depiction of insulator appearance.

Silicone rubber sheath and sheds complies with applicable ANSI and IEC standards.

Prepared By: Laurel Wallace