

MPS Catalog Number:

Date:

H3 90 10 058 CX SS 035

05/20/2021

End Fittings

Tower End Fitting:

Gain/12"-14" Hole Spacing

Anchor / Galv. Ductile Iron

Line End Fitting:

2 HL Drop Tongue / Galv. Ductile Iron

Material

Corona Ring (Tower):

None

Corona Ring (Line):

None

Corona Rings are recommended for applications of 230 kV and above

Mounting Angle:

17 deg

Number of Sheds:

35

Rod Diameter:

3 in

Weight Estimate:

122.9 lbs

56 kg

Dimensional Values

Section Length (L):

70.9 in 1,801 mm

Rubber Length (X):

58 in 1,473 mm

Shed spacing (S):

1.6 in 41 mm

Shed Projection (P):

2.7 in 68 mm

Dry Arc Distance:

61 in 1,549 mm

Leakage Distance:

228.3 in 5,799 mm

Electricals Values

60 Hz dry Flashover (Min. Withstand):

569 kV 534 kV

60 Hz Wet Flashover (Min. Withstand):

524 kV 419 kV

CIFO Positive (Min. Withstand):

993 kV 880 kV

CIFO Negative (Min. Withstand):

1034 kV 924 kV

Mechanical Values

Max. Design Cant. Load (MDCL):

2,180 lbs 9.7 kN

Specified Cant. Load (SCL):

4,360 lbs 19.4 kN

Specified Tensile Load (STL):

20,000 lbs 89.0 kN

This drawing contains confidential information that is the property of MacLean Power, L.L.C. ("MacLean"). Use of MacLean's confidential information without MacLean's express written consent is strictly prohibited and may expose you to legal liability. If you believe that you received this material in error, please destroy it or return it to "MacLean Power, L.L.C., 7801 Park Place Rd., York, South Carolina 29745, USA."

Notes:

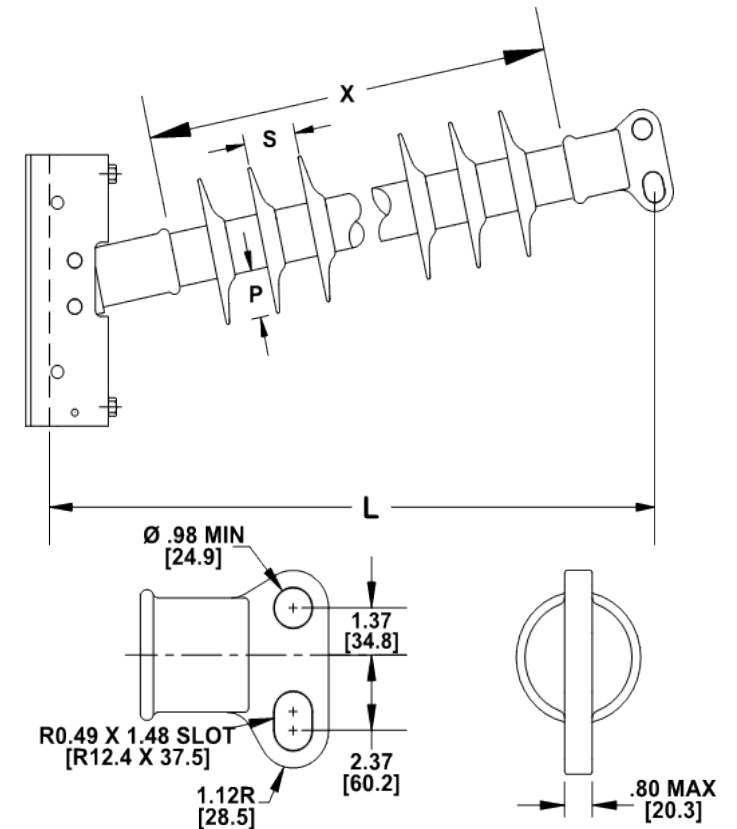
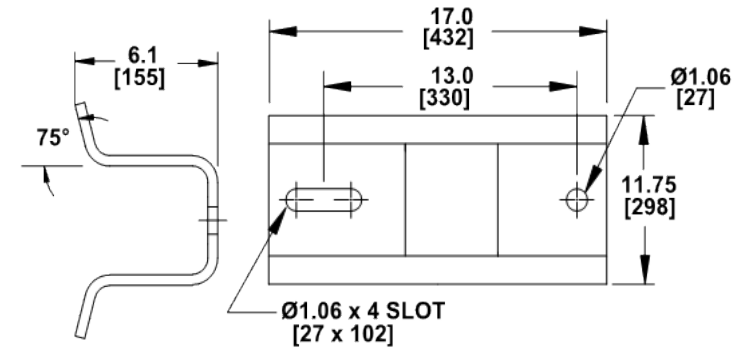

Dimension: inches [millimeters]

NOTE: Drawing not actual depiction of insulator appearance.

Silicone rubber sheath and sheds complies with applicable ANSI and IEC standards.

Prepared By: Laurel Wallace