

MPS Catalog Number:

Date:

H3 90 10 088 BA SS 043

05/20/2021

End Fittings

Tower End Fitting:

Gain/12"-14" Hole Spacing

Anchor / Galv. Ductile Iron

Line End Fitting:

2 HL Drop Tongue / Galv. Ductile Iron

Material

Corona Ring (Tower):

None

Corona Ring (Line):

6" Corona Ring

Corona Rings are recommended for applications of 230 kV and above

Mounting Angle:

17 deg

Number of Sheds:

43

Rod Diameter:

3 in

Weight Estimate:

149.6 lbs

68 kg

Dimensional Values

Section Length (L):

99.6 in 2,530 mm

Rubber Length (X):

88 in 2,235 mm

Shed spacing (S):

2 in 51 mm

Shed Projection (P):

2.7 in 68 mm

Dry Arc Distance:

89.7 in 2,278 mm

Leakage Distance:

297.3 in 7,551 mm

Electricals Values

60 Hz dry Flashover (Min. Withstand):

814 kV 764 kV

60 Hz Wet Flashover (Min. Withstand):

733 kV 599 kV

CIFO Positive (Min. Withstand):

1431 kV 1258 kV

CIFO Negative (Min. Withstand):

1450 kV 1314 kV

Mechanical Values

Max. Design Cant. Load (MDCL):

1,488 lbs 6.6 kN

Specified Cant. Load (SCL):

2,976 lbs 13.2 kN

Specified Tensile Load (STL):

20,000 lbs 89.0 kN

This drawing contains confidential information that is the property of MacLean Power, L.L.C. ("MacLean"). Use of MacLean's confidential information without MacLean's express written consent is strictly prohibited and may expose you to legal liability. If you believe that you received this material in error, please destroy it or return it to "MacLean Power, L.L.C., 7801 Park Place Rd., York, South Carolina 29745, USA."

Notes:

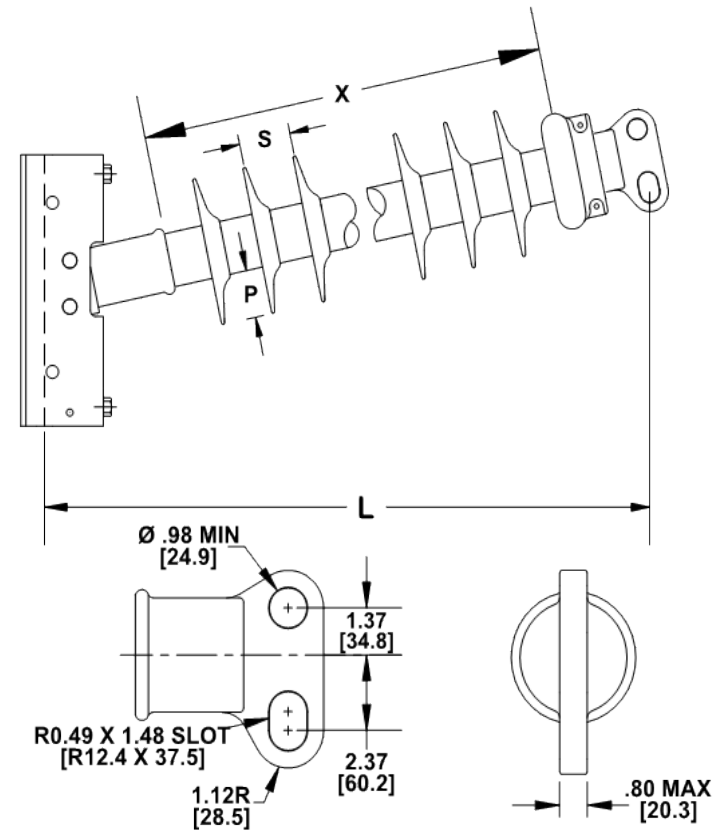
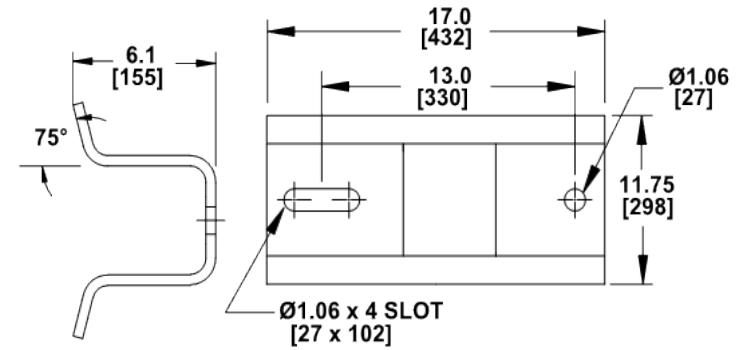

Dimension: inches [millimeters]

NOTE: Drawing not actual depiction of insulator appearance.

Silicone rubber sheath and sheds complies with applicable ANSI and IEC standards.

Prepared By: Laurel Wallace