

ITEM NO.	PART NUMBER	DESCRIPTION	QTY.
1	P90008X	PX FOAMED TUBE	1
2	F614574	3/4" x 6" BOLT / NUT ASSEMBLY	2
3	F338983	3/4" LOCKWASHER	2
4	P60103	SMALL PROFILE DEADEND BASE - ALUMINUM	1
5	P67578	5/8 - 11 x 8" STUD	2
6	P66000	SMALL PROFILE DEADEND PENTECH WASHER	4
7	F392614	5/8" OVAL EYE NUT	4

PAPER SIZE		DRAWING NUMBER	
B		3009-006	
REVISIONS			
REV.	ECO BY	ECO DATE	ECO NUMBER
A	MHK	10/31/14	01327

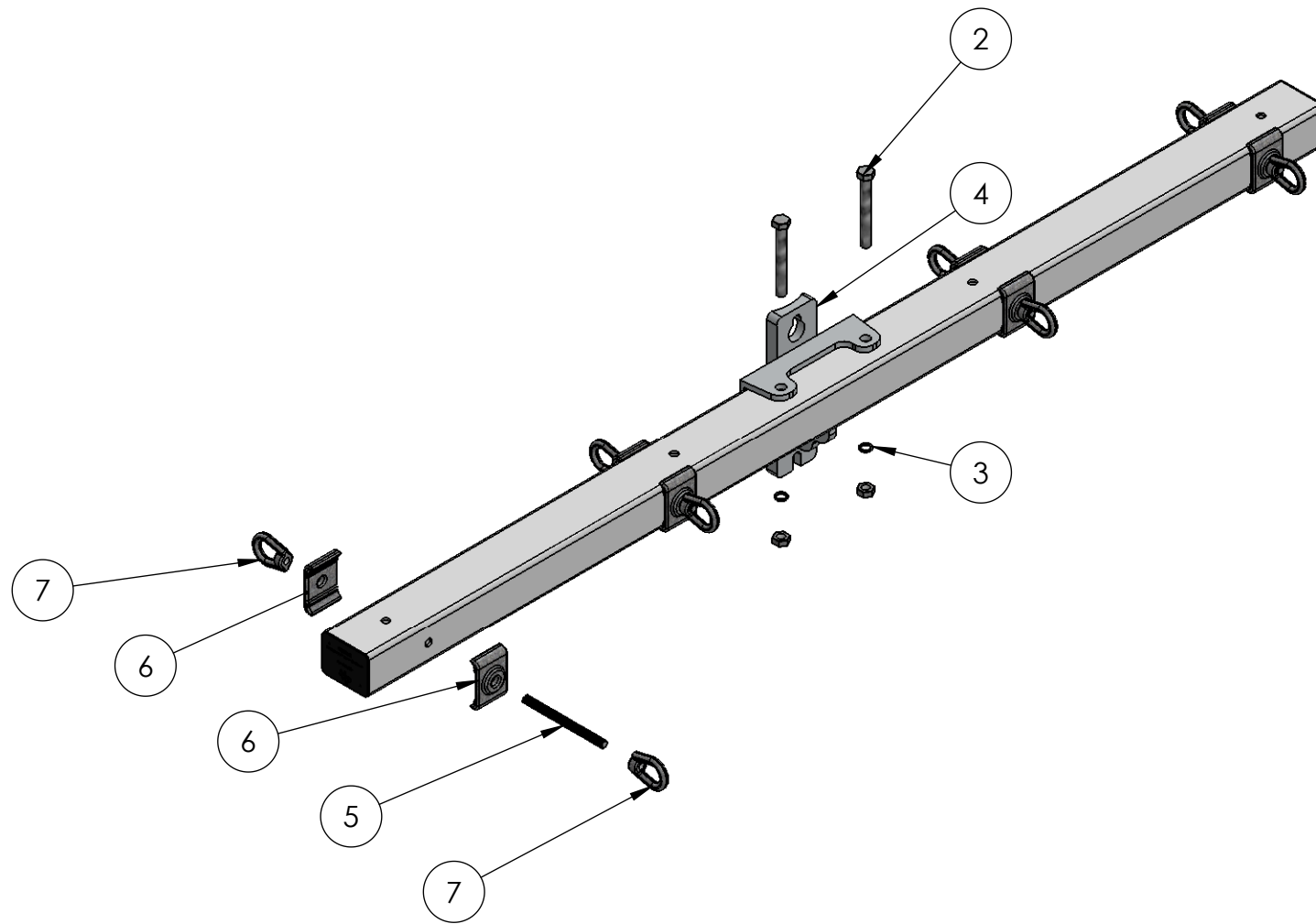

THIS DRAWING CONTAINS CONFIDENTIAL INFORMATION THAT IS THE PROPERTY OF MACLEAN POWER, L.L.C. ("MACLEAN"). USE OF MACLEAN'S CONFIDENTIAL INFORMATION WITHOUT MACLEAN'S EXPRESS WRITTEN CONSENT IS STRICTLY PROHIBITED AND MAY EXPOSE YOU TO LEGAL LIABILITY. IF YOU BELIEVE THAT YOU RECEIVED THIS MATERIAL IN ERROR, PLEASE DESTROY IT OR RETURN IT TO "MACLEAN POWER, L.L.C., 7801 PARK PLACE RD., YORK, SOUTH CAROLINA 29745, USA."

CATALOG NUMBER: PX08LD003-4E		CUSTOMER NUMBER:		PART NUMBER:		DRAWING NUMBER: 3009-006		DO NOT SCALE DRAWING	
PHYSICAL PROPERTIES UNLESS OTHERWISE SPECIFIED DIMENSIONS ARE IN: INCHES				MACLEAN POWER SYSTEMS 7801 PARK PLACE RD. YORK, SC. 29745 TEL. (803) 628-2100 FAX: (803) 628-2139		SHEET: 1 OF 2		CAD GENERATED DRAWING DO NOT MANUALLY UPDATE	
						DRAWING DESCRIPTION: PX DEADEND CROSSARM, 8 FT LG		DESIGN DATE: 10/31/14	
MATERIAL: FIBERGLASS		TOLERANCES ARE:		DRAWN BY: MHK		ENGINEER: mkadel		APPROVED: 11/03/14	
APPROX. WEIGHT : 65 LBS		.XX +/- .03		PRODUCT LINE: CROSSARMS		SCALE: 1:12.5			
VOLUME: IN3		.XXX +/- .015							
		X/XX +/- 1/32							
		ANGLES +/- 1°							

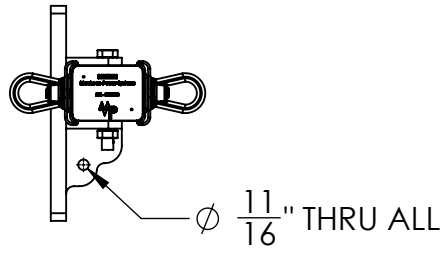
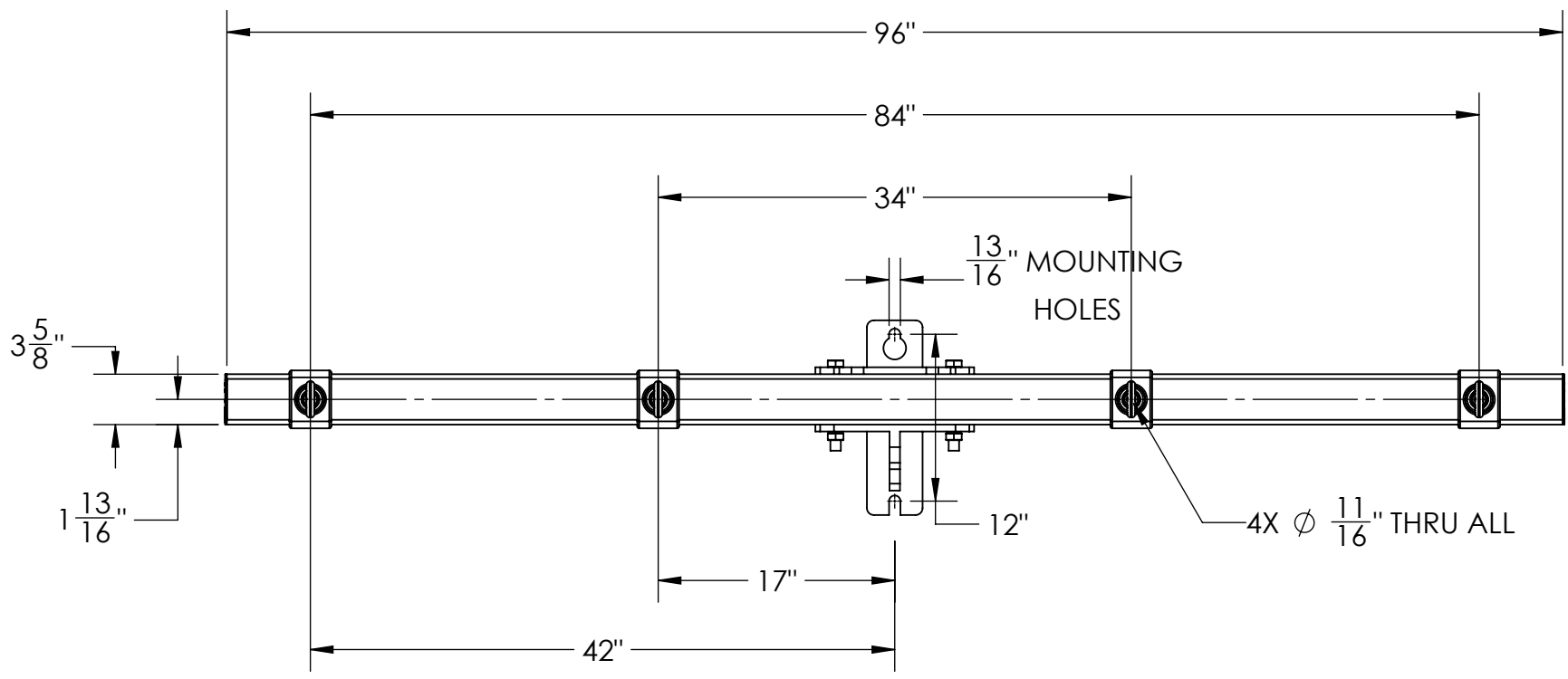
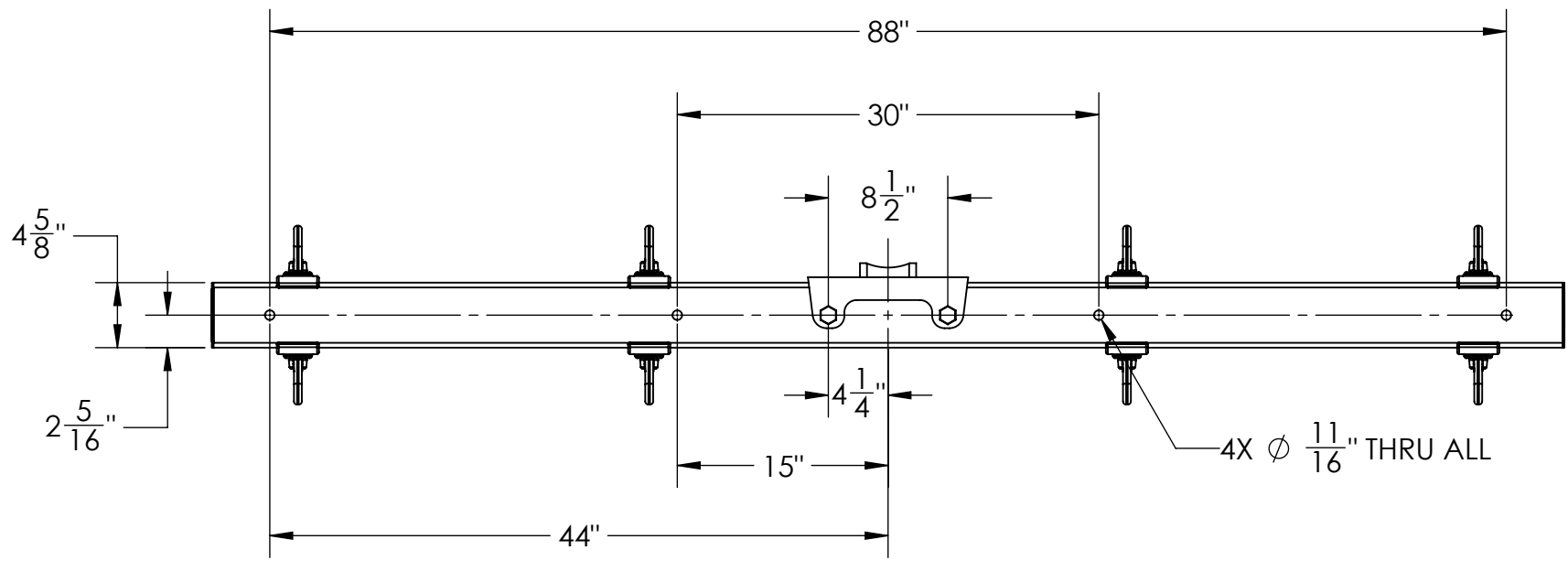

THIS DRAWING CONTAINS CONFIDENTIAL INFORMATION THAT IS THE PROPERTY OF MACLEAN POWER, L.L.C. ("MACLEAN"). USE OF MACLEAN'S CONFIDENTIAL INFORMATION WITHOUT MACLEAN'S EXPRESS WRITTEN CONSENT IS STRICTLY PROHIBITED AND MAY EXPOSE YOU TO LEGAL LIABILITY. IF YOU BELIEVE THAT YOU RECEIVED THIS MATERIAL IN ERROR, PLEASE DESTROY IT OR RETURN IT TO "MACLEAN POWER, L.L.C., 7801 PARK PLACE RD., YORK, SOUTH CAROLINA 29745, USA."

CATALOG NUMBER: PX08LD003-4E		CUSTOMER NUMBER:		PART NUMBER:		DRAWING NUMBER: 3009-006		DO NOT SCALE DRAWING	
PHYSICAL PROPERTIES UNLESS OTHERWISE SPECIFIED DIMENSIONS ARE IN: INCHES				TOLERANCES ARE: .XX +/- .03 .XXX +/- .015 X/XX +/- 1/32 ANGLES +/- 1°		SHEET: 2 OF 2		CAD GENERATED DRAWING DO NOT MANUALLY UPDATE	
						DRAWING DESCRIPTION: PX DEADEND CROSSARM, 8 FT LG		DESIGN DATE: 10/31/14	
MATERIAL: FIBERGLASS		APPROX. WEIGHT : 65 LBS		VOLUME: IN3		PRODUCT LINE: CROSSARMS		DRAWN BY: MHK	
								ENGINEER: mkadel	
								APPROVED: 11/03/14	
								SCALE: 1:12.5	



7801 PARK PLACE RD.
YORK, SC. 29745
TEL. (803) 628-2100 FAX: (803) 628-2139