

PAPER SIZE	CATALOG NUMBER
<b>B</b>	D1104-7

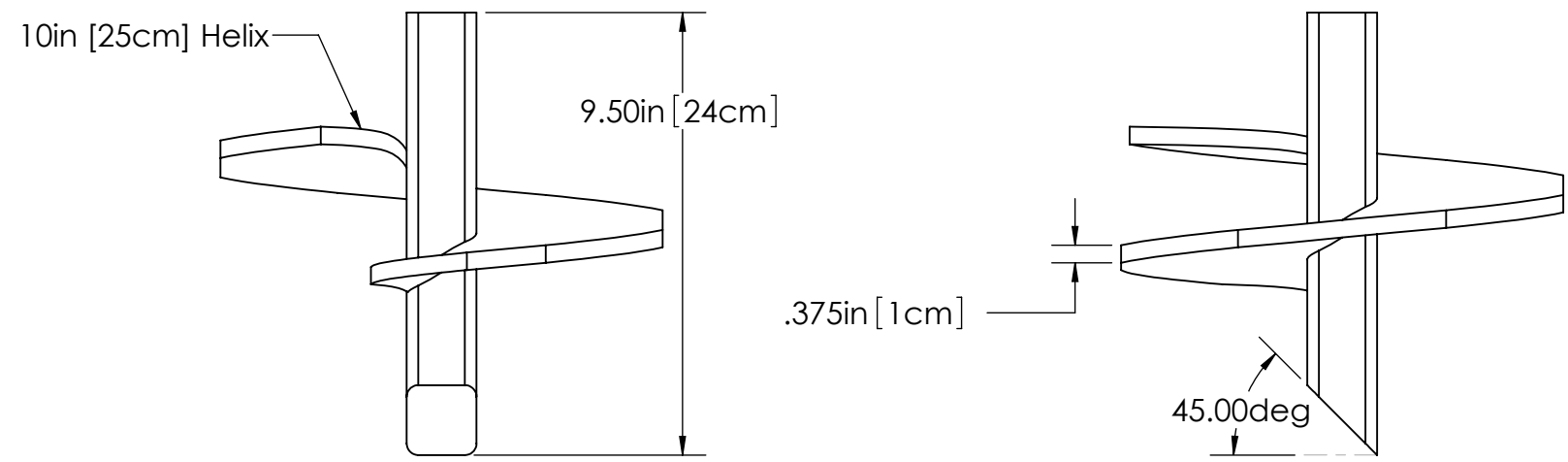
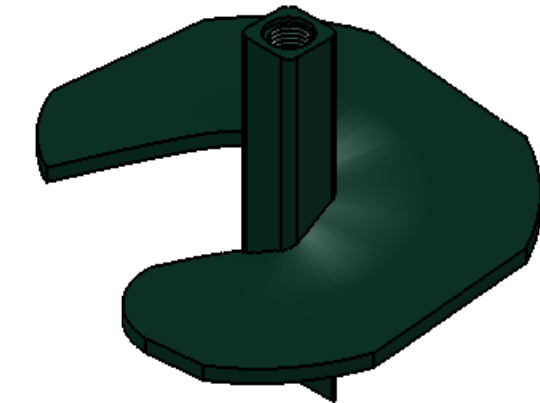
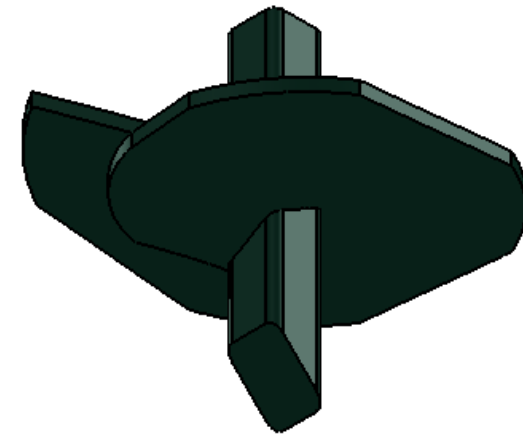
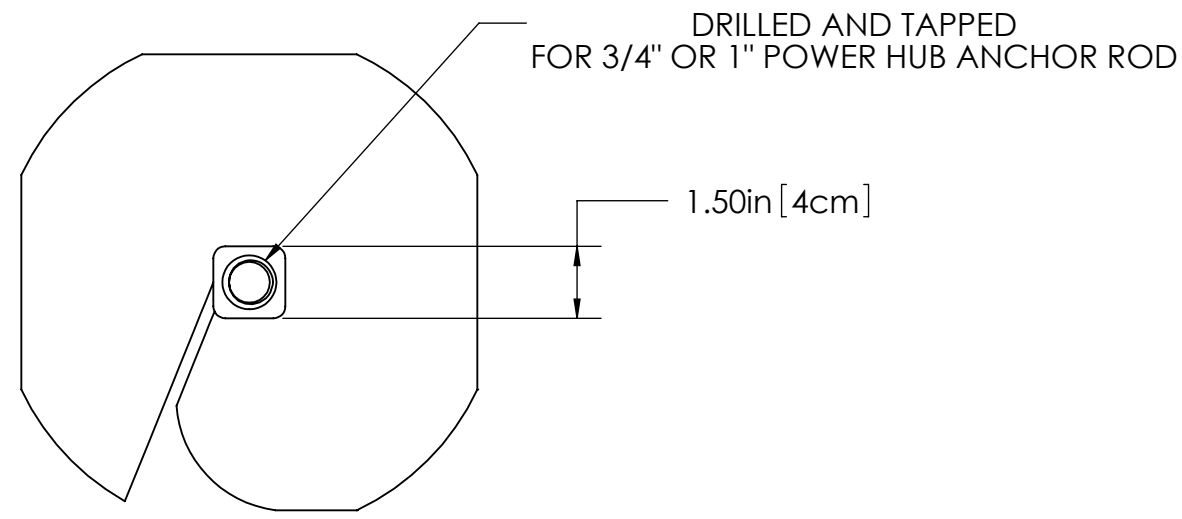

NOTES:

1. PAINT DARK GREEN AFTER FABRICATION.
2. ANCHOR IS RATED AT 7,000 FT-LBS (9,491 Nm) INSTALLATION TORQUE.
3. 3in [7.5cm] HELIX PITCH.

This drawing contains confidential information that is the property of MacLean Power, L.L.C. ("MacLean"). Use of MacLean's confidential information without MacLean's express written consent is strictly prohibited and may expose you to legal liability. If you believe that you received this material in error, please destroy it or return it to "MacLean Power, L.L.C., 11411 Addison Street, Franklin Park, Illinois 60131, "USA."



DRAWING NUMBER: D1104-7	
SHEET NAME: SHEET1	1 OF 1
PRODUCT DESCRIPTION 1-1/2" SOLID SQUARE POWER HUB ANCHOR	
DRAWN BY: CRL	DATE: 3/12/12