

A | B | C | D | E | F

PAPER SIZE		DRAWING NUMBER	
B SIZE		GD-J1086	
REV	REVISION DATE	ECO	
A	07-10-12	10662	
B	08-13-12	10690	

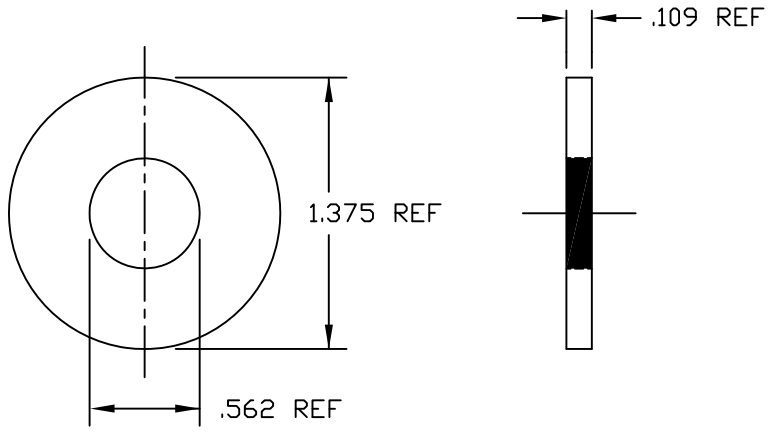

NOTES:

1. MATERIAL: HOT ROLLED CARBON STEEL
2. ALL DIMENSIONS ARE REFERENCE AND ARE IN INCHES.
3. HOT DIP GALVANIZED PER ASTM A-153.

PART NO. F614672

This drawing contains confidential information that is the property of MacLean Power, L.L.C. ("MacLean"). Use of MacLean's confidential information without MacLean's express written consent is strictly prohibited and may expose you to legal liability. If you believe that you received this material in error, please destroy it or return it to "MacLean Power, L.L.C., 11411 Addison, Franklin Park, Illinois 60131, USA."

DRAWING-COMPUTER LOCATION

TOLERANCES UNLESS SPECIFIED	
inches	
0.XX	----
0.XXX	----
ANGLE	----



DRAWN BY	ENGINEER	CHECKER	CATALOG #	SCALE	DESIGN DATE
PDR	RRL	JBB	J1086	NTS	07-10-12
DRAWING TITLE / DESCRIPTION					DRAWING NUMBER
ROUND WASHERS 1-3/8 X 12GA					GD-J1086