

8 7 6 5 4 3 2 1

PAPER SIZE		DRAWING NUMBER	
B		GD-J8154	
REV	REVISED BY	REVISION DATE	ECO #
A	RC	07/31/09	9598

NOTES:

- 1) ALL DIMENSIONS ARE REFERENCE AND ARE IN INCHES EXCEPT AS NOTED.
- 2) HOT DIP GALVANIZED.

ITEM	QTY	DESCRIPTION
1	1	BOLT THIMBLEEYE ANG 5/8
2	1	NUT SQUARE 5/8

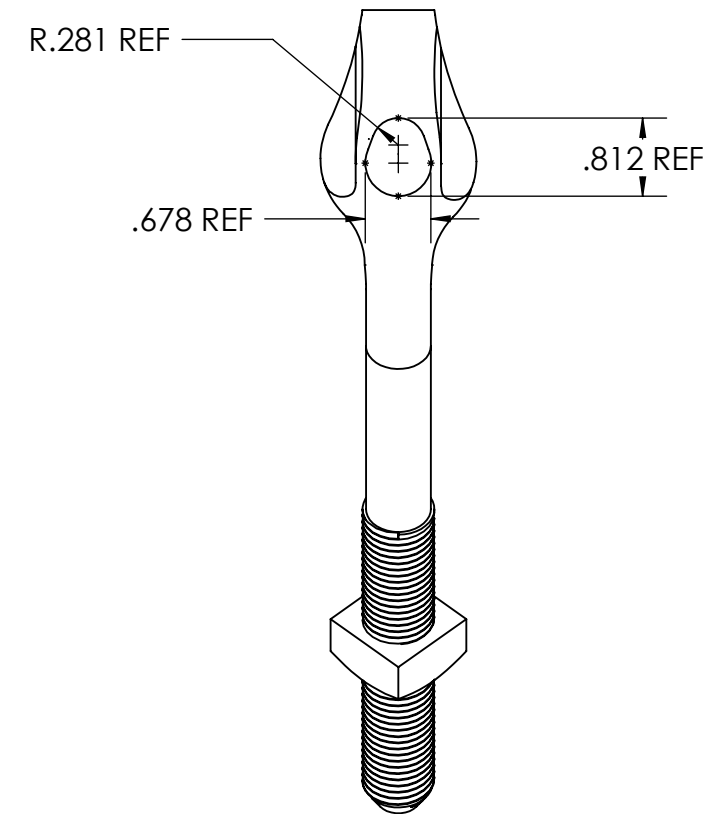
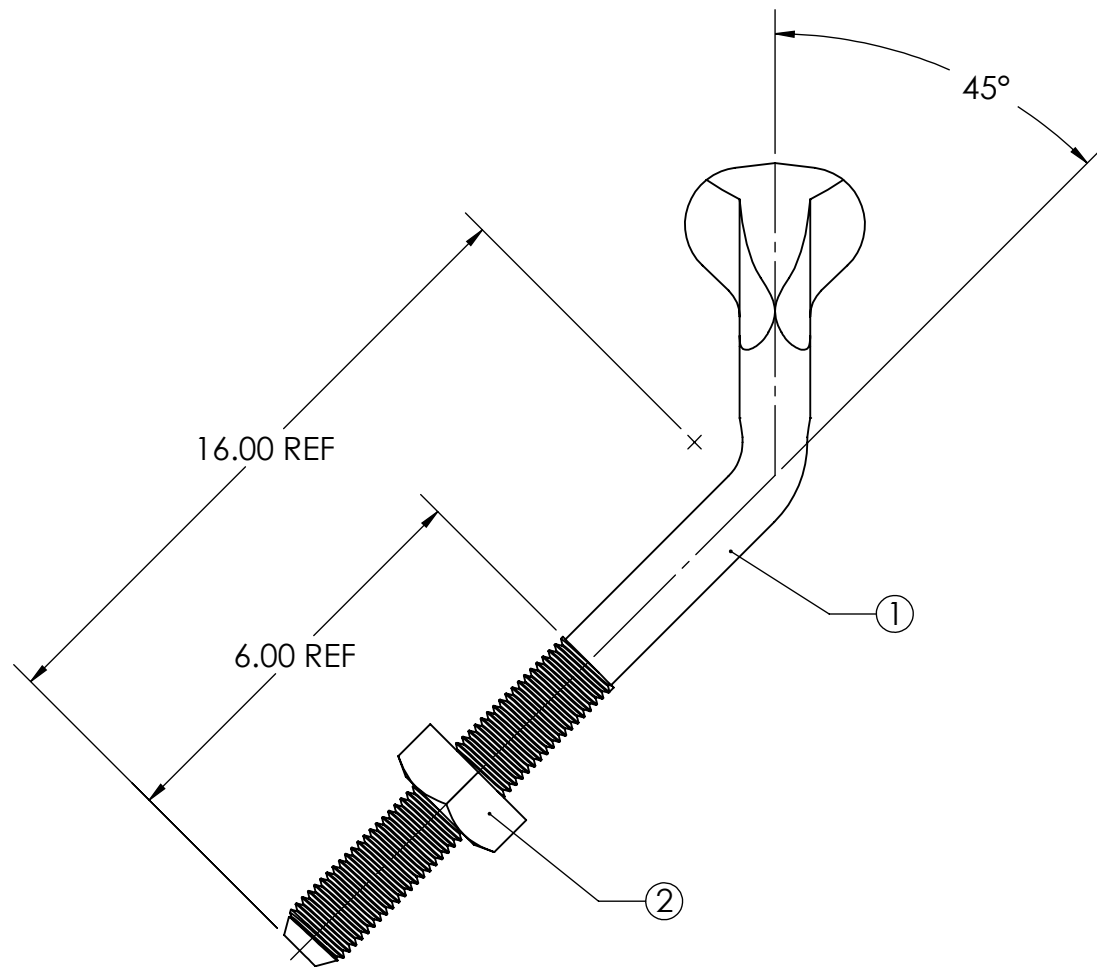

This drawing contains confidential information that is the property of MacLean Power, L.L.C. ("MacLean"). Use of MacLean's confidential information without MacLean's express written consent is strictly prohibited and may expose you to legal liability. If you believe that you received this material in error, please destroy it or return it to "MacLean Power, L.L.C., 11411 Addison Street, Franklin Park, Illinois 60131, "USA."

F614679

UNLESS OTHERWISE SPECIFIED DIMENSIONS ARE IN:	
INCHES [MM]	
TOLERANCES ARE:	
.XX [.X]	-----
.XXX [.XX]	-----
ANGLES	-----

CATALOG NUMBER J8154



**MACLEAN
POWER
SYSTEMS**

11411 ADDISON STREET
FRANKLIN PARK, IL. 60131

TEL. (847) 455-0014 FAX: (847) 455-0029

DRAWING NUMBER:		GD-J8154		DO NOT SCALE DRAWING	
SHEET NAME:		Sheet1		1 OF 1	
DRAWING DESCRIPTION:		BOLT THIMBLEEYE ANG 5/8			
DESIGN DATE:		07/31/09			
DRAWN BY:		RC			
ENGINEER:		DEK			
APPROVED:		FJS			
DRAWING SCALE:		1:2			

8 7 6 5 4 3 2 1