

A | B | C | D | E | F

PAPER SIZE	DRAWING NUMBER	
B SIZE	GD-J8636	
REV	REVISION DATE	ECO
A	08-31-09	9624

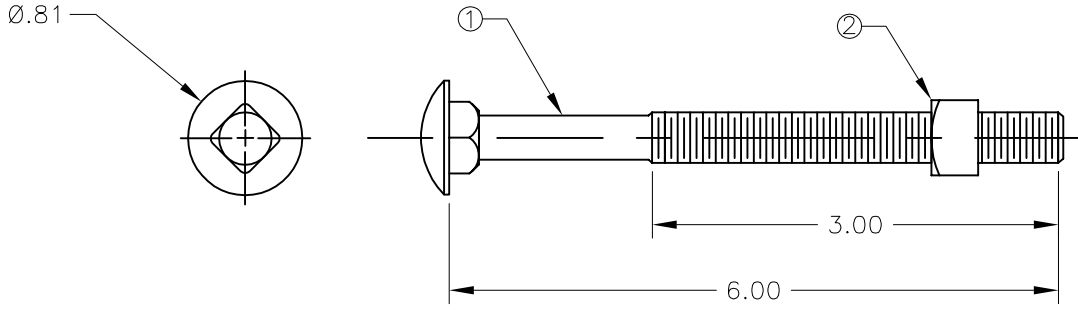

ITEM	QUANTITY	DESCRIPTION
1	1	.375 CARRIAGE BOLT
2	1	.375 REGULAR SQUARE NUT

NOTES:
 1) ALL DIMENSIONS ARE REFERENCE AND IN INCHES.
 2) ALL COMPONENTS MECHANICAL GALVANIZED.

CATALOG NUMBER J8636

This drawing contains confidential information that is the property of MacLean Power, L.L.C. ("MacLean"). Use of MacLean's confidential information without MacLean's express written consent is strictly prohibited and may expose you to legal liability. If you believe that you received this material in error, please destroy it or return it to "MacLean Power, L.L.C., 11411 Addison, Franklin Park, Illinois 60131, USA."

F614535

DRAWING-COMPUTER LOCATION:

TOLERANCES UNLESS SPECIFIED	
inch	
0.XX	— — —
0.XXX	— — —
ANGLE	— — —



DRAWN BY	ENGINEER	CHECKER	CATALOG #	SCALE	DESIGN DATE
RC	RRL	FJS	J8636	---	08-31-09
DRAWING TITLE / DESCRIPTION					DRAWING NUMBER
BOLT CARRIAGE 3/8"					GD-J8636