

THREE PHASE INSTALLATION LAYOUT

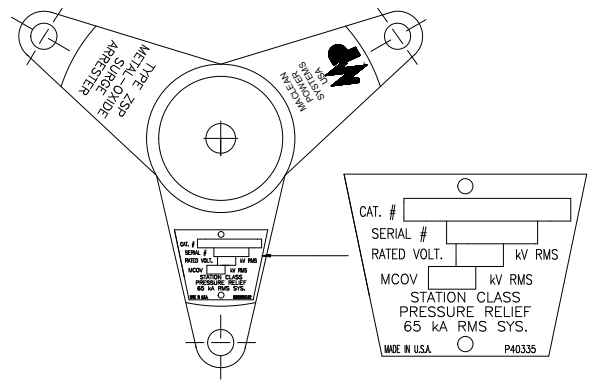

TRIPOD BASE AND NAMEPLATE

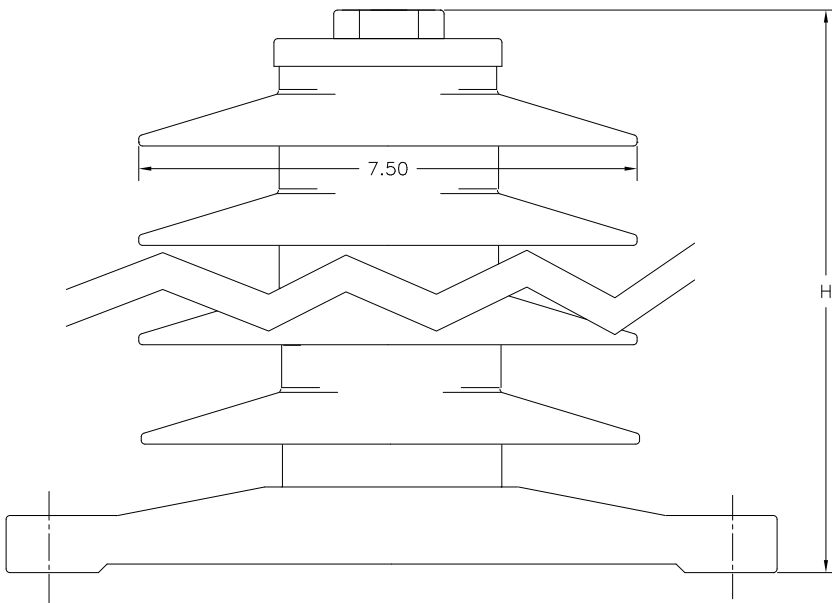

PHYSICAL CHARACTERISTICS

HEIGHT IN./(MM)	CREEP IN./(MM)	WEIGHT LBS./(kg)
7.6/(193)	17.8/(453)	18.0/(8.2)

Min. Clearance - in./(mm)		Fault Withstand
A	R	
12/(305)	6/(152)	80 kA

ELECTRICAL CHARACTERISTICS

RATING kV-RMS	MCOV kV-RMS	F.O.W. kV-CREST	MAX SWITCH. kV-CREST
9	7.65	24.7	17.6

MAX DISCHARGE VOLTAGE (kV-CREST)					
1.5 kA	3 kA	5 kA	10 kA	20 kA	40 kA
19.0	20.0	20.9	22.5	24.8	28.2

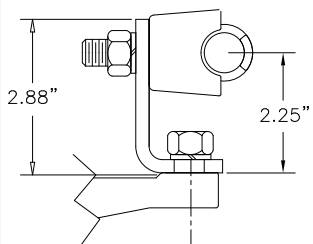

TOP TERMINAL OPTION 1
USED ON -4111, -4131

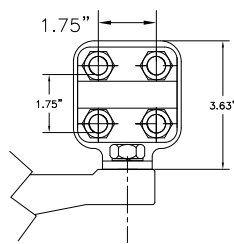

TOP TERMINAL OPTION 2
USED ON -4211, -4231

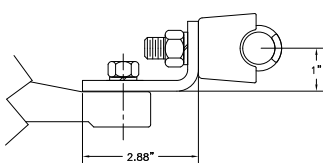

BOTTOM TERMINAL OPTION 1
USED ON -4111, -4211

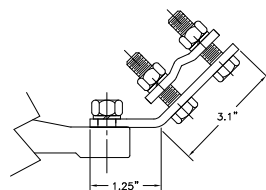

BOTTOM TERMINAL OPTION 3
USED ON -4231, -4131



MACLEAN POWER SYSTEMS

www.maclepower.com

POLYMER HOUSED GAPLESS METAL OXIDE
ZSP STATION CLASS ARRESTER
9 KV RATED
7.65 KV MCOV

NOT TO SCALE

THIS DRAWING IS THE PROPERTY OF MACLEAN POWER SYSTEMS AND EMBODIES A CONFIDENTIAL PROPRIETARY DESIGN IN WHICH MPS RETAINS ALL PATENTS AND PROPRIETARY RIGHTS, INCLUDING EXCLUSIVE RIGHT OF USE, MANUFACTURE AND SALE. BY ACCEPTING THIS DRAWING, THE RECIPIENT AGREES NOT TO DISCLOSE, REPRODUCE, OR USE ANY INFORMATION CONTAINED HEREIN WITHOUT THE PRIOR WRITTEN CONSENT OF MPS.

DATE 11/04/14

DRAWN ZA

CHECKED

ZSP0009-1XX1

DO NOT SCALE DRAWING

SHEET 1 OF 1