

THREE PHASE INSTALLATION LAYOUT

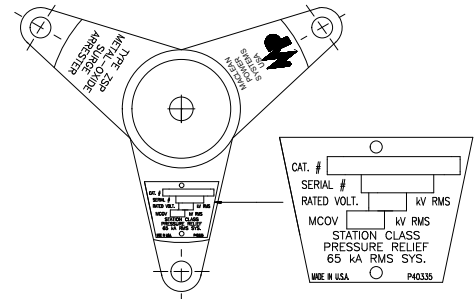

TRIPOD BASE AND NAMEPLATE

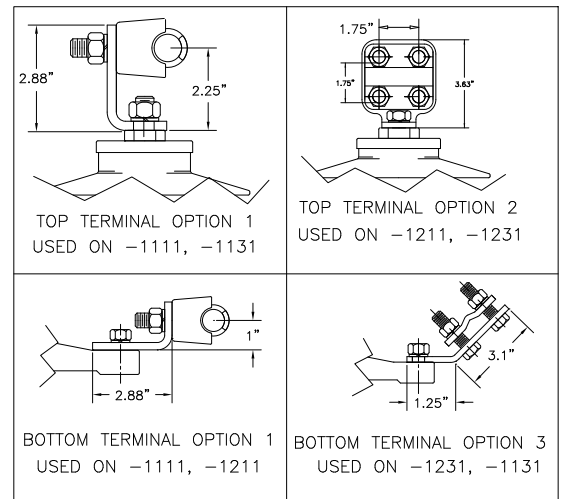

PHYSICAL CHARACTERISTICS

HEIGHT IN./(MM)	CREEP IN./(MM)	WEIGHT LBS./(kg)	Min. Clearance - in./(mm)		Fault Withstand
			A	R	
23.3/(593)	71.2/(1807)	52/(23.6)	25/(635)	19/(483)	80 kA

ELECTRICAL CHARACTERISTICS

RATING kV-RMS	MCOV kV-RMS	F.O.W. kV-CREST	MAX SWITCH. kV-CREST	MAX DISCHARGE VOLTAGE (kV-CREST)					
				1.5 kA	3 kA	5 kA	10 kA	20 kA	40 kA
60	48	169.6	134.2	140.0	145.8	150.6	159.4	169.6	188.4



MACLEAN POWER SYSTEMS

www.maclepower.com

TYPE ZSP POLYMER
STATION CLASS
MOV LIGHTNING ARRESTER
60 KV RATED
48 KV MCOV

DATE 07/23/14

DRAWN ZA

CHECKED

ZSP0060-1XX1

DO NOT SCALE DRAWING

SHEET 1 OF 1

THIS DRAWING IS THE PROPERTY OF MACLEAN POWER SYSTEMS AND EMBODIES A CONFIDENTIAL PROPRIETARY DESIGN IN WHICH MACLEAN POWER SYSTEMS RETAINS ALL PATENTS AND PROPRIETARY RIGHTS, INCLUDING EXCLUSIVE RIGHT OF USE, MANUFACTURE AND SALE. BY ACCEPTING THIS DRAWING, THE RECIPIENT AGREES NOT TO DISCLOSE, REPRODUCE OR USE ANY INFORMATION CONTAINED HEREIN WITHOUT THE PRIOR WRITTEN CONSENT OF MACLEAN POWER SYSTEMS.